

BOOT

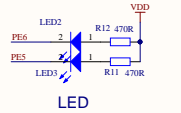

LED

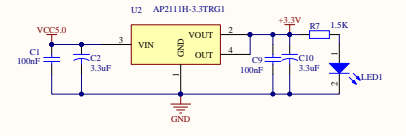

POWER

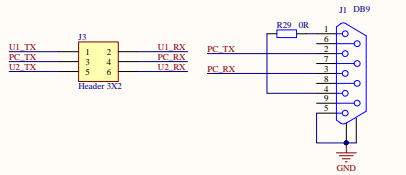

USART

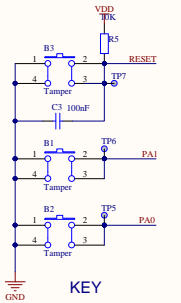

KEY

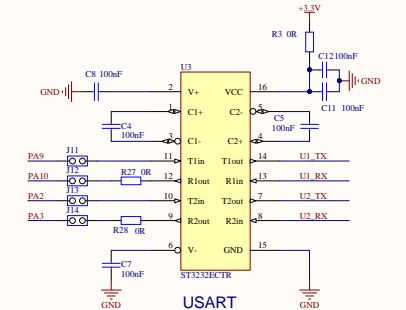

USART

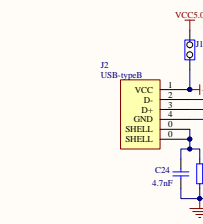
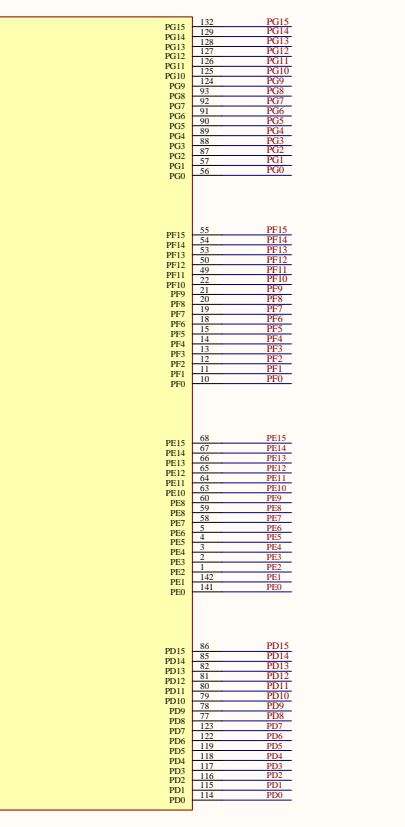
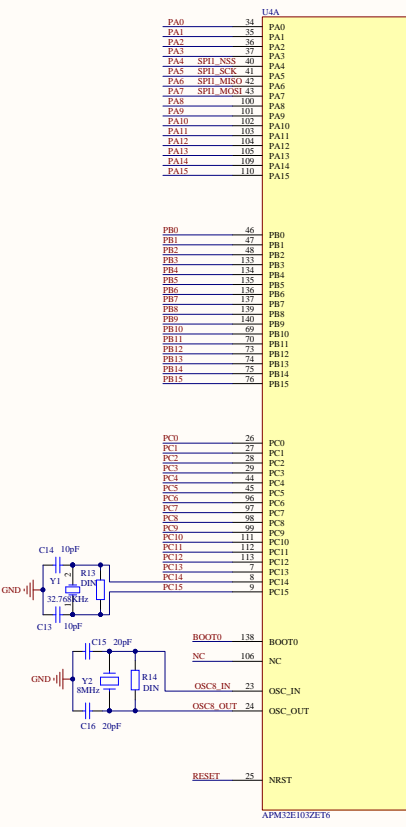

USB

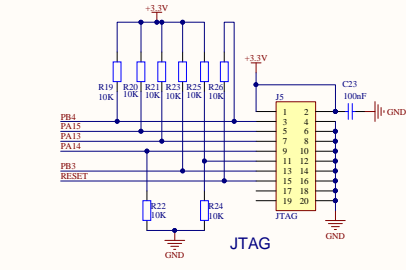

JTAG

